

# RockCast Easy Order Form

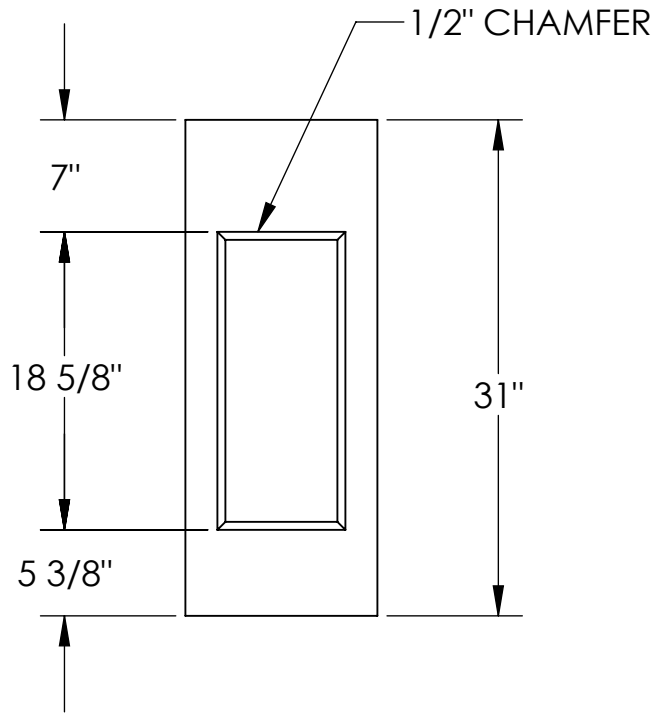

Profile

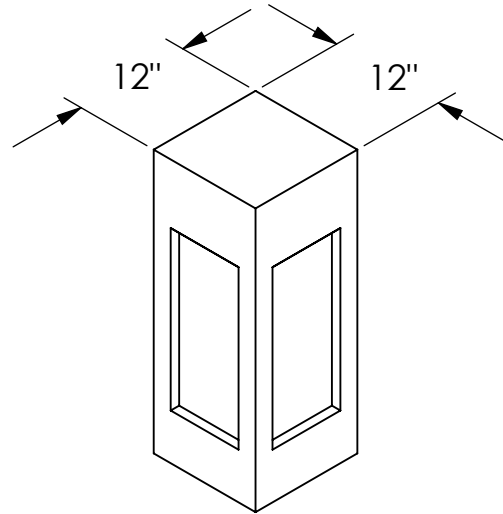

Qty:     

Mold #: <b>MS-2584</b>		Buffstone <input type="checkbox"/> Crystal White <input type="checkbox"/> Other <input type="checkbox"/>
 <b>ROCKCAST</b> 4600 DEVITT DRIVE CINCINNATI, OHIO 45246	Project:	Approved By: